



# Wraptor™ A6200

WRAP PRINTER APPLICATOR

## User Manual

---

## Copyright and Trademarks

### Disclaimer

This manual is proprietary to **Brady** Worldwide, Inc. (hereafter "**Brady**"), and may be revised from time to time without notice. **Brady** disclaims any understanding to provide you with such revisions, if any.

This manual is copyrighted with all rights reserved. No portion of this manual may be copied or reproduced by any means without the prior written consent of **Brady**.

While every precaution has been taken in the preparation of this document, **Brady** assumes no liability to any party for any loss or damage caused by errors or omissions or by statements resulting from negligence, accident, or any other cause. **Brady** further assumes no liability arising out of the application or use of any product or system described, herein; nor any liability for incidental or consequential damages arising from the use of this document. **Brady** disclaims all warranties of merchantability of fitness for a particular purpose.

**Brady** reserves the right to make changes without further notice to any product or system described herein to improve reliability, function, or design.

### Trademarks

Wraptor A6200 is a trademark of **Brady** Worldwide, Inc.

Microsoft and Windows are registered trademarks of Microsoft Corporation.

All brand or product names referenced in this manual are trademarks (™) or registered trademarks (®) of their respective companies or organizations.

© 2020 **Brady Worldwide, Inc.** All Rights Reserved.

Y4875106

Revision A

**Brady Worldwide, Inc.**  
6555 West Good Hope Road  
P.O. Box 2131  
Milwaukee, WI 53201-2131  
[www.bradyid.com](http://www.bradyid.com)

**Sales/Customer Support:**(888) 250-3082

---

## Brady Warranty

Our products are sold with the understanding that the buyer will test them in actual use and determine for him or herself their adaptability to his/her intended uses. Brady warrants to the buyer that its products are free from defects in material and workmanship, but limits its obligation under this warranty to replacement of the product shown to Brady's satisfaction to have been defective at the time Brady sold it. This warranty does not extend to any persons obtaining the product from the buyer.

THIS WARRANTY IS IN LIEU OF ANY OTHER WARRANTY, EXPRESS OR IMPLIED, INCLUDING, BUT NOT LIMITED TO, ANY IMPLIED WARRANTY OF MERCHANTABILITY OR FITNESS FOR A PARTICULAR PURPOSE, AND OF ANY OTHER OBLIGATIONS OR LIABILITY ON BRADY'S PART. UNDER NO CIRCUMSTANCES WILL BRADY BE LIABLE FOR ANY LOSS, DAMAGE, EXPENSE OR CONSEQUENTIAL DAMAGES OF ANY KIND ARISING IN CONNECTION WITH THE USE, OR INABILITY TO USE, BRADY'S PRODUCTS.

## Safety and Environment

Please read and understand this manual before using the Wraptor A6200 printer for the first time. This manual describes all of the main functions of the Wraptor A6200 printer.

### Precautions

Before using the Wraptor A6200 printer, please note the following precautions:

- Read all instructions carefully before operating the printer and prior to performing any procedure.
- Do not place the unit on an unstable surface or stand.
- Do not place anything on top of the unit.
- Keep the top clear of obstructions.
- Always use the printer in a well ventilated area. Do not block the slots and opening on the unit, which are provided for ventilation.
- Only use the power source indicated on the rating label.
- Use only the power cord that comes with the unit.
- Do not place anything on the power cord.
- Keep the area around the fan inlet clear to avoid overheating.

---

## Technical Support and Registration

### Contact Information

For repair or technical assistance, locate your regional Brady Technical Support office by going to:

- **United States:** [www.bradyid.com/techsupport](http://www.bradyid.com/techsupport)
- **Europe:** [www.bradyeurope.com/services](http://www.bradyeurope.com/services)
- **Asia Pacific:** [www.brady.co.uk/landing-pages/global-landing-page](http://www.brady.co.uk/landing-pages/global-landing-page)
- **Australia:** [www.bradyid.com.au/en-au/supportlanding](http://www.bradyid.com.au/en-au/supportlanding)
- **Canada:** [www.bradycanada.ca](http://www.bradycanada.ca)
- **Latin America:** [www.bradylatinamerica.com](http://www.bradylatinamerica.com)

### Registration Information

To register your printer go to:

- [www.bradycorp.com/register](http://www.bradycorp.com/register)

### Repair and Return

If for any reason you need to return the product for repair, please contact **Brady** Technical Support for repair and replacement information.

## Document Conventions

When using this document, it is important that you understand the conventions used throughout the manual.

- All user actions are indicated by **Bold** text.
- References to menus, dialog boxes, buttons and screens are indicated by *Italicized* text.

# Contents

## 1 • Introduction

<b>System Specifications</b> .....	<b>1</b>
Physical Dimensions .....	1
Environmental Ranges .....	2
Materials Storage Specifications .....	2
Electrical Specifications .....	2
<b>System Requirements</b> .....	<b>2</b>
<b>Safety</b> .....	<b>2</b>
Automatic Stops .....	3
<i>Wrapper Module</i> .....	3
<i>Top Cover</i> .....	4
Electrical Safety .....	4

## 2 • Setup

<b>Unpacking the Printer</b> .....	<b>5</b>
What's in the Box .....	5
Registration .....	5
<b>Printer Components</b> .....	<b>6</b>
<b>Power</b> .....	<b>7</b>
<b>Printer Settings</b> .....	<b>7</b>
Advance to Next Label .....	8
Wire or Cable Tension .....	8
File Location .....	8
Keyboards .....	9
Language .....	9
Units of Measure .....	10
Date and Time .....	10
Printer Name .....	10
<b>Software for Creating Labels</b> .....	<b>11</b>
<b>Connecting the Printer</b> .....	<b>12</b>
USB .....	12
Wi-Fi .....	12
<i>Search to Connect</i> .....	12
<i>Manually Enter Settings</i> .....	13
Ethernet Network .....	13
<b>Installing the Windows Driver (Optional)</b> .....	<b>14</b>
<b>Loading Ribbon</b> .....	<b>15</b>
<b>Loading Label Supply</b> .....	<b>17</b>
<b>Rewinder Accessory</b> .....	<b>21</b>
Installing the Rewinder .....	21
Starting a New Roll .....	23
Removing Spent Label Backing .....	24

### 3 • General Operation

<b>Using the Touch Screen</b> .....	<b>25</b>
Navigation and Status Bar .....	26
Material Details .....	26
<b>Creating Labels</b> .....	<b>26</b>
<b>Printing: Quick Start</b> .....	<b>27</b>
Printing and Wrapping .....	27
<i>Wrap Quality</i> .....	28
Printing Without Wrapping (Print Only) .....	28
Wrapping Without Printing (Apply Only) .....	29
<b>Printing: Details</b> .....	<b>29</b>
Managing Print Jobs .....	29
<i>Finding a Print Job</i> .....	30
<i>Adding a Job to the Queue</i> .....	31
<i>Deleting a Job</i> .....	31
Managing the Print Queue .....	32
Running Jobs .....	33
Settings .....	34
<i>Print Adjustments</i> .....	34
<i>Print Queue</i> .....	35
<b>Transferring Print Jobs Between Printers</b> .....	<b>35</b>
Import Print Jobs .....	36
<b>Running a File Using a Barcode Scanner</b> .....	<b>36</b>
Set Up the Scanner .....	37
Set Up the Label Files and Barcodes .....	37
Print from a Barcode .....	37

### 4 • Maintenance

<b>Displaying System Information</b> .....	<b>38</b>
<b>Installing an Upgrade</b> .....	<b>38</b>
<b>Updating Y and B Values</b> .....	<b>39</b>
<b>Cleaning</b> .....	<b>39</b>
Cleaning the Tarp .....	39
Cleaning the Print Head .....	40
Cleaning the Rollers and Peel Plate .....	41
Cleaning the Sensors .....	43
Cleaning the Fan Filter .....	46

### 5 • Troubleshooting

<b>Wrap is not applied correctly</b> .....	<b>47</b>
<b>Labels jam on the tarp</b> .....	<b>49</b>
<b>Label material jams within the printer</b> .....	<b>49</b>
<b>Label material feeds incorrectly</b> .....	<b>49</b>
<b>Print quality is poor</b> .....	<b>50</b>
<b>Print is too light</b> .....	<b>50</b>

---

Nothing happens when I place a wire in the jaws .....	51
No print jobs are in the printer .....	51
<b>A • Regulatory Compliance</b>	
<b>Agency Compliance and Approvals .....</b>	<b>52</b>
United States .....	52
<i>FCC Notice</i> .....	52
Canada .....	52
Mexico .....	52
Europe .....	53
<i>RoHS Directive 2011/65/EU, 2015/863/EU</i> .....	53
<i>Batteries Directive 2006/66/EC</i> .....	53
Turkey .....	53
China .....	54
<b>Wireless Regulatory Information .....</b>	<b>54</b>
United States .....	54
Canada .....	55
Mexico .....	55
European Union .....	55
International .....	56
Japan .....	56
<b>B • Licensing</b>	
End User License Agreement for Microsoft Windows CE© .....	57

# 1 Introduction

---

The Wraptor™ A6200 Wrap Printer Applicator prints and wraps labels on wires and cables from 0.06 to 0.25 inches in diameter, including any casing around the wire or cable. Design labels on your computer using Brady Workstation software. Transfer the labels to the printer for printing and wrapping.

## System Specifications

The Wraptor A6200 printer has the following specifications:

- 300 dots per inch (11.8 dots per mm) print resolution
- 1.5 inches per second (38.1 mm per second) print speed
- Wrap speed 7 seconds or less to print and apply)
- Accommodates wires between 0.06" (1.524 mm) and 0.25" (6.35 mm) in diameter
- Supports label widths of 1" (25.4 mm) or 0.5" (12.7 mm)
- Supports labels from 0.75" (19.05 mm) to 1.25" (31.75 mm) high (1.25" maximum printable height)
- One-year warranty
- Accepts USB drives for added storage capability and standalone operation. USB drives must be formatted with FAT, FAT32, or exFAT file systems. The Wraptor A6200 printer does not support NTFS.

## Physical Dimensions

Physical	U.S. Units	Metric Units
Dimensions with touch screen folded flat (width, height, depth)	8.8 x 8.3 x 11.7 in	22.4 x 21.1 x 29.7 cm
Weight	8.7 lbs	3.9 kg



## Environmental Ranges

Environmental	Operation	Storage
Temperature*	50 to 105°F (10 to 40.6°C)	0 to 140°F (-18 to 60°C)
Relative Humidity	20 to 80% non-condensing	10 to 95% non-condensing
* Performance decreases for B427 labels above 80°F (26.7°C). (B427 labels are self-laminating translucent vinyl labels.)		

Exposing the printer to direct sunlight is not recommended.

## Materials Storage Specifications

Label supplies and ribbon for use with this unit must be stored in its original packaging in an environment in which the temperature is below 80°F and 60% relative humidity.

## Electrical Specifications

<b>Input Voltage to Adapter</b>	100 - 240 V~
<b>Current to Adapter</b>	1.5 A
<b>Frequency to Adapter</b>	50/60 Hz
<b>Input Voltage to Printer</b>	18 V DC

## System Requirements

Following are the *recommended* requirements for the computer on which you install the Wraptor A6200 *Printer Driver*:

- Operating system:
- Microsoft® Windows® 7
- Microsoft Windows 8
- Microsoft Windows 10

## Safety

The following information is necessary for the safe operation of the Wraptor A6200 printer. Be sure to read this section prior to setting up or operating the printer.

Always be sure to adhere to the safety standards regulating your operating environment. Also adhere to the following safety rules in addition to your specific standards:



**WARNING!** Do not wear loose clothing—such as long sleeves or scarves—that could become caught in the unit.



**CAUTION!** Keep areas around the unit clean at all times.



**CAUTION!** The tear blade in the bottom front of the printer has a sharp edge.

## Automatic Stops

For safe operation, moving parts in the printer automatically stop when the top cover is open. Moving parts in the wrapper mechanism stop when the wrapper module is open.

### *Wrapper Module*

When the wrapper module is opened, the wrapping mechanism stops. With the wrapper module open you can print and peel labels as well as feed labels.



### Top Cover

Printing and wrapping stops when the top cover is opened. The top cover must be closed to feed labels.



**WARNING!** Do not disable the automatic stop mechanisms. Doing so may cause injury.

### Electrical Safety



**CAUTION!** Make sure the power outlet is grounded.



**WARNING!** Turn off power and unplug unit before performing any service or maintenance on the Wraptor A6200 printer.

## 2 Setup

---

### Unpacking the Printer

Save all packaging material in case you have to ship the printer back to the supplier.



CAUTION! The tear blade in the bottom front of the printer has a sharp edge.

#### What's in the Box

- Wraptor™ A6200 Wrap Printer Applicator.
- USB drive containing the following:
  - *Wraptor A6200 User's Manual*
  - *Wraptor A6200 Quick Start Guide*
  - Print Driver
  - *Driver Installation Guide*
- Printed Quick Start Guide
- *Brady Workstation Product & Wire Identification Software Suite* with download instructions and license key.
- Power cord and AC adapter.
- USB cable
- Label supply: A62-3-427 die cut 1" x 1.25"
- Ribbon: M71-R4300 black

#### Registration

Register your printer online at [www.bradycorp.com/register](http://www.bradycorp.com/register) and receive free product support and updates!

## Printer Components

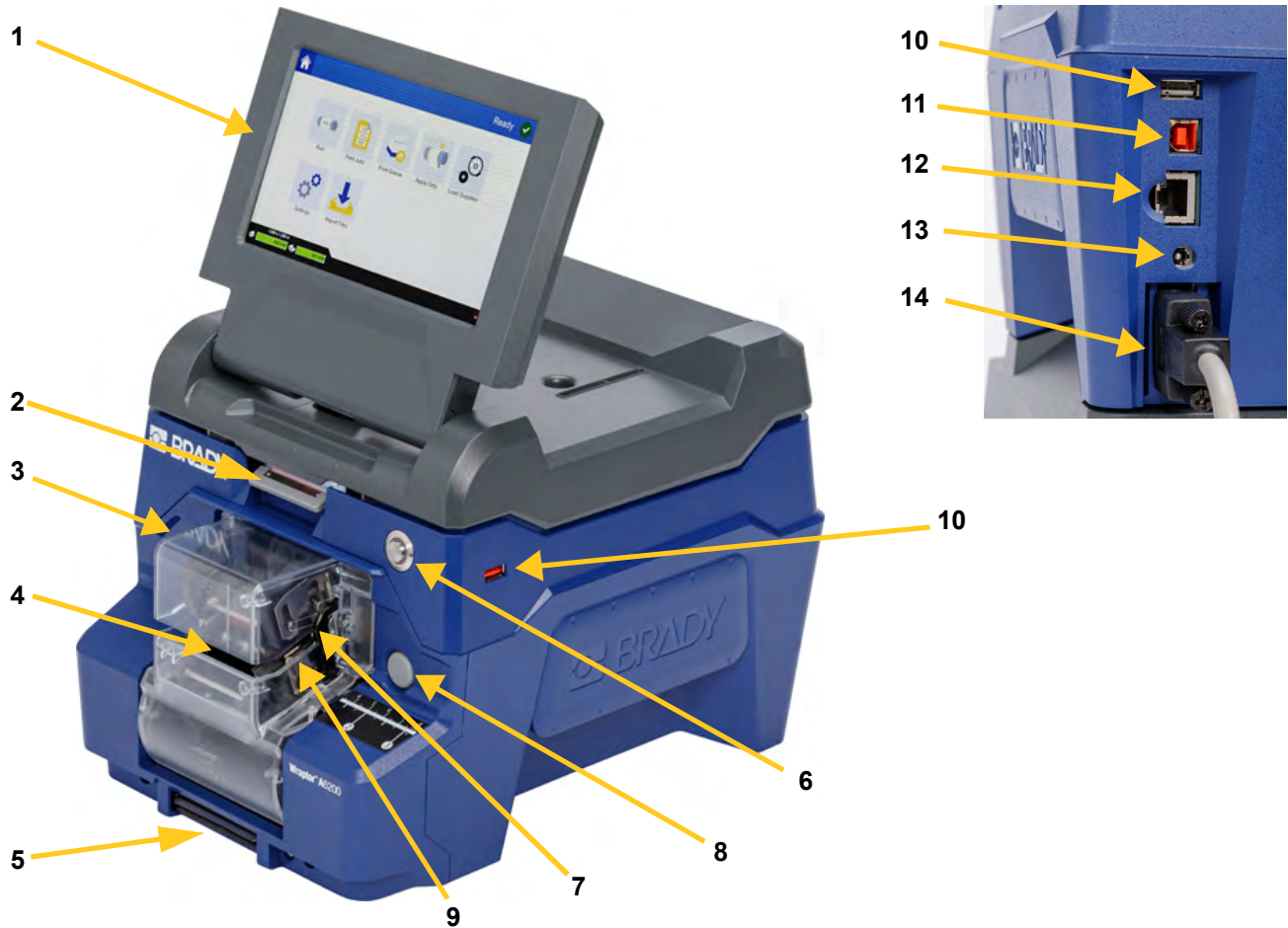

1. **Touch screen:** Tap with your finger to operate the menus. See *"Using the Touch Screen"* on page 25.
2. **Cover latch:** Lift up to open the top cover.
3. **Wrapper module:** The clear enclosure and everything within it. The module attaches to the printer with a hinge and can fold open for loading labels and cleaning. The wrapper automatically stops when the wrapper module is open.
4. **Wrapper:** Mechanism that wraps a label around the wire.
5. **Tear blade:** Use to tear spent liner off the printer.
6. **Power button:** Push to turn the printer on or off.
7. **Trigger bar:** One on each side. The trigger bars initiate wrapping. See *"Printing and Wrapping"* on page 27.
8. **Wrapper module release:** Push to release the wrapper module to open it for loading labels or cleaning.
9. **Jaws:** Hold the wire in place as the label is applied.

10. **USB port (type A):** Connect a USB drive. The USB drive must be formatted with FAT, FAT32, or exFAT file systems. NTFS is not compatible with the Wraptor A6200 printer. The printer has two type A USB ports, one on the back and one on the side.
11. **USB device port (type B):** Connect the printer to a computer's USB port so that you can send labels created with Brady Workstation software directly to the printer.
12. **Ethernet connection:** Connect the printer to a Local Area Network (LAN).
13. **Power:** Connect the power supply to the printer.
14. **Rewinder port:** Connect the optional accessory for rewinding used label backing. See *"Rewinder Accessory"* on page 21.

## Power

The printer is powered through a Brady supplied AC/DC power adapter.



**CAUTION!** Use only the 18 V Brady adapter and power cord provided with the printer.

### To connect power and turn on the printer:

1. If outside of North America or Europe, use a safety certified power cord with the Brady-provided 18 V adapter.
2. Connect the power cord to the power supply provided and to an electrical outlet.



**CAUTION!** Make sure the outlet is grounded.

3. Connect the power supply to the printer.
4. Press the power button on the front of the printer. The first time you turn on the printer it walks you through configuring the settings. Follow the instructions on the touch screen.

## Printer Settings



The first time you turn on the printer, instructions on the touch screen walk you through the settings that must be configured the first time you use the printer. The following sections detail these settings should you need to change them in the future, and provide instruction on a few additional settings to consider when setting up the printer.

For an introduction to using the touch screen, see *"Using the Touch Screen"* on page 25. For print settings see *"Settings"* on page 34.

## Advance to Next Label

Choose how you want the printer to advance to the next label in a file.



### To set how labels advance:

1. From the home screen, tap **Settings**. 
2. Tap **System Configuration**, then **Advance to Next Label**.
3. Tap the desired value.
  - In **Auto** mode, the printer automatically advances to the next label after a print and wrap. This is the typical mode of operation.
  - In **Manual** mode, you must advance the printer to the next label using the navigation buttons on the Printing (run) screen. See *“Running Jobs” on page 33*.
4. Tap  to go back to the previous screen.

## Wire or Cable Tension

When wrapping a label on a wire, the wrapper jaws clamp on the wire and hold it taught for wrapping.

### To turn tension on or off:

1. From the home screen, tap **Settings**. 
2. Tap **System Configuration**,
3. Tap **Apply Tension**, and then tap one of the following.
  - **Off**: When off, the jaws on the printer clamp the wire, but do not apply tension. This can be useful for cables sensitive to tension, such as fiber optic cables, but can decrease the quality of the wrap.
  - **On**: Recommended for normal operation. When on, the jaws on the printer clamp onto the wire and apply tension to achieve a smooth wrap.
4. Tap  to go back to the previous screen.

## File Location

Choose whether the printer accesses files from memory or from a USB drive.

### To set the file location:

1. From the home screen, tap **Settings**. 
2. Tap **System Configuration**, then **File Location**.
3. Tap the desired value.

- **Internal Memory:** Choose this option if the printer is directly connected to the computer with a USB cable or on a network. When you print a label from Brady Workstation software, the print file is sent to the printer's internal memory. When you tap *Print Jobs* on the home screen, the printer accesses the list of files from internal memory.
  - **External USB:** Choose this option when transferring files from one Wraptor A6200 printer to another. Insert a USB drive into the USB port on the printer. When you print a label from Brady Workstation software, the print file is sent to the USB drive. When you tap *Print Jobs* on the home screen, the printer accesses the list of files from the USB drive. For details see "*Transferring Print Jobs Between Printers*" on page 35.
4. Tap  to go back to the previous screen.

## Keyboards

The printer displays a keyboard on the screen when you have to type data, such as when you name the printer. Because different languages use different sets of characters, you may need keyboards with different character sets. By default the printer uses the appropriate keyboard for the language setting. For example, if the printer language is set to Simplified Chinese, the printer will automatically display a keyboard with Simplified Chinese characters. If you only want to use the default keyboard, you do not need to change any keyboard settings.



### To select keyboards:

1. From the home screen, tap **Settings**. 
2. Tap **System Configuration**, then **Virtual Keyboard**. A list of supported keyboards is displayed.
3. Tap the check box for each keyboard that you want to have available when using the printer. You can select multiple keyboards. The default keyboard (that for the printer language) is shown at the top of the list and cannot be deselected.

When you use the keyboard later, the default keyboard is shown. Tap the globe icon to switch to a different enabled keyboard. Each time you tap the globe icon, the display switches to another enabled keyboard. 

## Language

### To set the language for text on the touch screen:



1. With the printer turned on, tap **Settings**. 
2. Tap **System Configuration**, then **Language**.
3. Tap the desired language. You may need to scroll to see all available languages. Touch the screen and drag your finger up or down to scroll.
4. Tap  to go back to the previous screen.



## Units of Measure

Set the unit of measure to inches or millimeters.



To set the unit of measure:

1. From the home screen, tap **Settings**. 
2. Tap **System Configuration**, then **Measurement Units**.
3. Tap either **Inches** or **Millimeters**.
4. Tap  to go back to the previous screen.

## Date and Time

Set the printer's clock to the current date and time.

To set the date and time:

1. From the home screen, tap **Settings**. 
2. Tap **System Configuration**, then **Date and Time**. The left side of the screen displays the current settings.
3. To change the settings, tap the controls on the right.
  - **Use 24-hour format:** Tap the switch to change between 24-hour format and 12-hour format with AM and PM. When the switch is red, the printer uses 12-hour format. When the switch is green, the printer uses 24-hour format.
  - **Set date:** Tap to display date controls. To change the date, either tap on an elements and select a new value, or tap the arrows above or below an element.
  - **Set time:** Tap to display time controls. To change the time, either tap on an elements and select a new value, or tap the arrows above or below an element.
4. Tap  to go back to the previous screen.

## Printer Name

The printer name is displayed when a computer searches for the printer on a Wi-Fi connection.

To change the printer name:

1. With the printer turned on, tap **Settings**. 
2. Tap **Connection**, and then tap **Printer Name**. The printer displays a keyboard.  
The printer name can only contain the characters A-Z, a-z, 0-9, and -. Regardless of the keyboards you have enabled for your printer, the printer displays a keyboard with the allowed characters.

3. Use the keyboard on the touch screen to type a name for the printer.
4. When finished tap .

When using Brady Workstation software on Wi-Fi, this name is shown when selecting a printer. See “*Software for Creating Labels*” on page 11 and “*Connecting the Printer*” on page 12.

## Software for Creating Labels

Install labeling software on your computer, set up the connection to the printer, then use the software to design labels and send them to the printer.

Brady Workstation software provides a variety of apps to simplify label creation for specific purposes. It also provides easy-to-use apps for custom label design. The printer comes with a license for the Brady Workstation Product & Wire Identification Suite.

### To install the Product & Wire Identification Suite:

1. Make sure your computer is connected to the internet.
2. Go to [workstation.bradyyid.com/PWID](http://workstation.bradyyid.com/PWID).
3. Follow the instructions on the screen to download and install the software.
4. When you run the software and open an app that requires activation, follow the instructions on the screen to activate the software. Use the license ID and password on the printed insert that came with the printer.

For other Brady Workstation software or additional licenses, go to [www.workstation.bradyyid.com](http://www.workstation.bradyyid.com) or contact your Brady representative.

## Connecting the Printer

Connect to the labeling software using a Wi-Fi® wireless network, Ethernet network, or a USB cable.

### USB

To connect to a computer via USB 2.0, plug the provided USB cable into the printer and the computer. Brady Workstation software automatically detects the printer when connected via USB cable.



**Note:** If you are not using Brady Workstation software, you need to install the printer driver. See the *Driver Installation Guide* PDF file on the USB drive that came with the printer.

### Wi-Fi

Connect to a Wi-Fi network either by searching for and selecting a network, or by manually entering the network settings. Once connected, the printer can communicate with devices on that network.

**Note:** The on-screen keyboard for entering passwords and user names contains only the characters allowed for network user names and passwords. Thus, you may see a keyboard that differs from those you have enabled in *Settings*.

If you are not using Brady Workstation software, you need to install the printer driver. See the *Driver Installation Guide* PDF file on the USB drive that came with the printer.

### ***Search to Connect***

This is the easiest and most common method for connecting.

**To connect to a Wi-Fi wireless network:**

1. Make sure the printer is turned on.

2. Tap **Settings**.



3. Tap **Connection**.

4. Tap **Wi-Fi Network** to turn on Wi-Fi. The printer searches for Wi-Fi networks and displays a list of networks found. Touch and drag to scroll the list. (If you need to identify the network by static IP address or DHCP, see “*Manually Enter Settings*” on page 13.)

Tap the network that you want to use.

- If the network is not locked, simply tap it and the printer connects to it.
- If the network is locked, as indicated by a lock symbol, tap the network and a key pad opens.

Enter the password and tap .



**Note:** If your network uses WEP authentication, a menu displays instead so that you can enter both the password and the WEP index (key).

- If the network you need is not in the list, it may not be discoverable. Scroll to the bottom of the list and tap **Other**. Choose either **Personal Network** or **Enterprise Network**. The system displays settings appropriate to your selection. You may need information from your IT department to complete the settings.

### Manually Enter Settings

Use this method if you need to identify the network by static IP or DHCP. Contact your network administrator for assistance.

#### To connect to a Wi-Fi wireless network:

1. Make sure the printer is turned on.
2. Tap **Settings**. 
3. Tap **Connection**.
4. Tap **Advanced Network Settings**.
5. Tap **Wi-Fi**.
6. Tap **IP Settings** and then tap one of the following.
  - **DHCP:** DHCP addressing is dynamic and the system uses a DNS server to obtain the printer IP address for you.
  - **Static:** Select static addressing to manually enter the printer's IP address.
7. Tap the back button to return to the *Wi-Fi* screen. 
8. Fill in the remaining available settings with help from your network administrator.
9. Tap  to return to the home screen.



### Ethernet Network

This section describes how to configure the printer to communicate via an Ethernet (TCP/IP) connection.

**Note:** If using a Windows driver (see *“Installing the Windows Driver (Optional)”* on page 14) it is best to configure the Ethernet connection before installing the driver. If the driver is already installed before configuring the Ethernet connection, you may need to edit the port settings for the printer in Windows to update the IP address.

#### To configure network settings on the printer:

1. Make sure the printer is turned on.

2. Tap **Settings**. 
3. Tap **Connection**.
4. Tap **Advanced Network Settings**, and then tap **Ethernet**.
5. Tap **IP Settings**.
  - If your network uses DHCP to automatically assign IP addresses, tap **DHCP**.
  - If your network requires manually providing IP addresses, tap **Static**. Tap the back button  to return to the *Network* screen. Get assistance from your network administrator to fill in the IP address and other settings on the *Network* screen.
6. Tap the home button to return to the home screen. 

## Installing the Windows Driver (Optional)

If you are using Brady Workstation software, you do not need to install the windows driver.

You must install the Windows driver if you are using any of the following.

- Older Brady software such as LabelMark.
- Third-party software.
- The Data Automation app in Brady Workstation.

See the *Driver Installation Guide* PDF file on the USB drive that came with the printer.

## Loading Ribbon

Ribbon can be loaded with the power on or off. The Wraptor A6200 printer uses BMP71 series R4300 ribbon, part number M71-R4300.

### To change the ribbon:

1. Pull up on the latch and lift open the cover on the printer.



2. To remove the ribbon in the printer, pinch together the tabs on either side of the ribbon cartridge and pull the ribbon cartridge out of the printer.



If the ribbon is spent, recycle the cartridge according to local regulations. If the ribbon is not spent, store it in a cool, dry place. Unused ribbon will last up to six months before deterioration sets in.

3. Orient the new cartridge as shown above with the label on the top and the Brady logo on the bottom. Grasp the finger tabs and place it directly over the print head, pushing slightly to snap it into place.

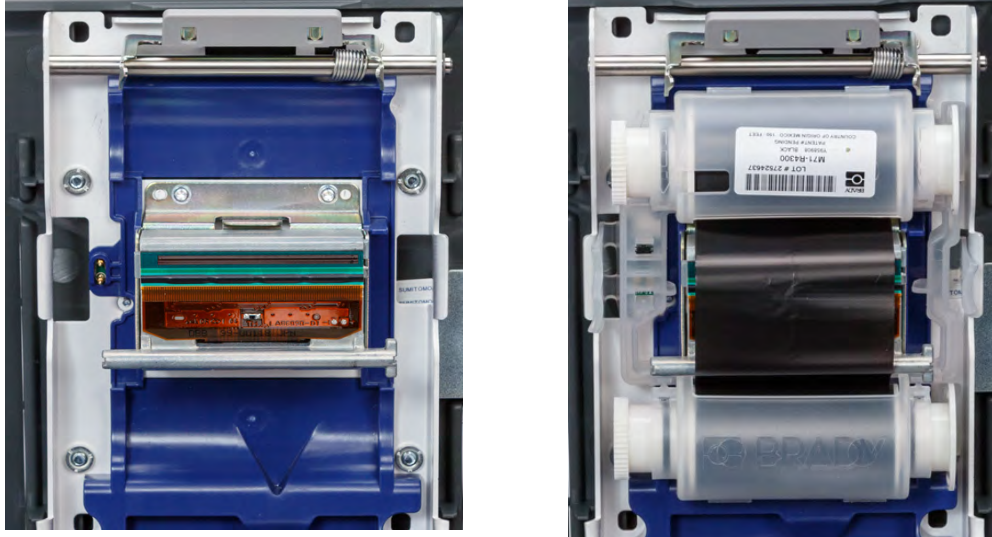

If the ribbon cartridge has been used, turn the top spool to wind used ribbon onto the spool leaving only new, unused ribbon exposed.



4. Close the cover until it latches.

You can see what ribbon is currently installed and how much ribbon remains in the status bar on the touch screen. See *“Using the Touch Screen”* on page 25 and *“Material Details”* on page 26.

## Loading Label Supply

Brady labels come equipped with smart-cell technology that enables the printer and Brady labeling software to recognize the type of label and automatically set many label formatting details.

Use only genuine Brady A62 series labels.

### To load labels:

1. Turn the printer on and tap **Load Supplies** on the home screen, then tap **Load Supply**. (See *"Using the Touch Screen"* on page 25.)
2. Pull up on the latch and lift open the cover on the printer.



3. Remove the existing label roll. (The printer comes with a liner installed in the label path. Note the correct placement before removing it.)
  - a. Leave at least six inches of empty liner on the end of the roll. You will need the length of empty liner when installing this roll again in the future.
  - b. Press the gray button on the front of the printer to open the wrapper module.
  - c. Press the yellow button to open the peeler door.



peeler door closed

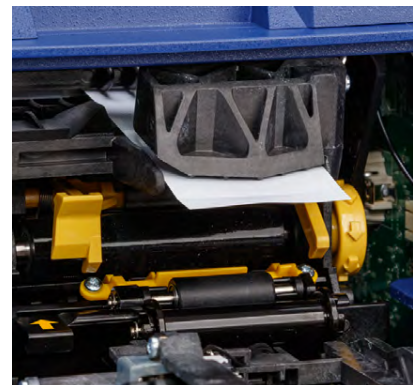

peeler door open



- d. Gently rewind the spool with your finger to back the label supply out from the label path.

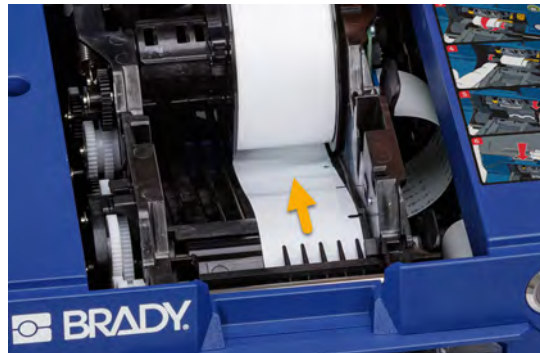

- e. Grasp the label roll and gently pull up out of the label well.
4. Remove the protective tape covering the leading end of the labels on the new label roll.
  5. With labels coming off the bottom of the spool toward the front of the printer, grasp the roll with the rabbit ears pointing up and insert the labels straight into the compartment, gently pushing until it clicks into place. Make sure the smart cell on the label roll aligns with the reader in the label well.

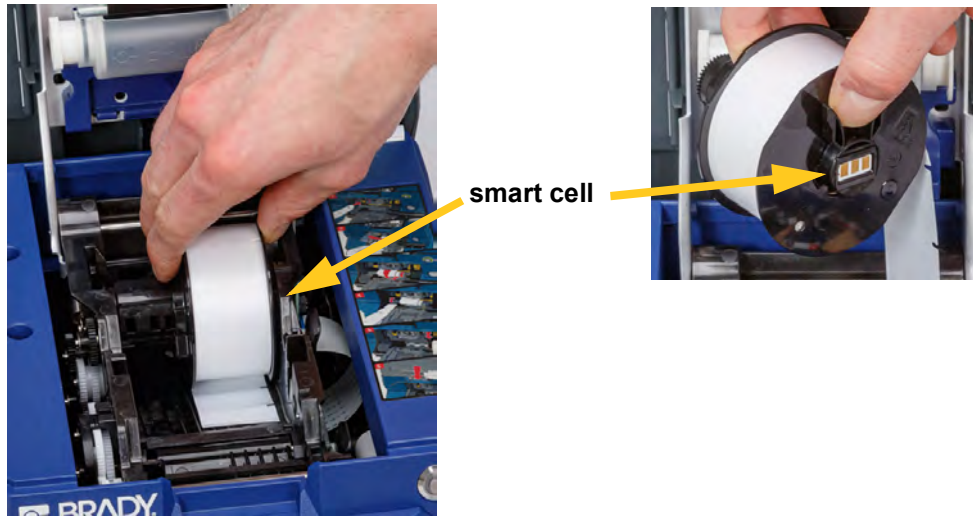

6. Press the gray button on the front of the printer to open the wrapper module.

7. Feed the leading edge of the label roll through to the front of the printer. The first few inches of the roll should have just the liner without any labels on it.



**CAUTION!** Feeding labels past this point will cause labels to become stuck during printing. Make sure you are feeding bare liner.

8. Slide the liner to the right, between the peel plate and peel assist plate.



peel assist plate

peel plate



9. Press the yellow button to open the peeler door. Pull about six inches of liner through to the front.

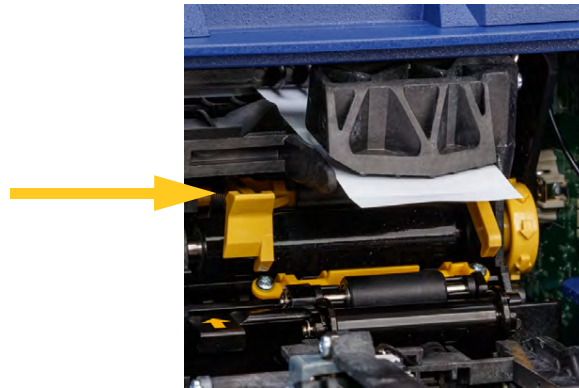

**peeler door open**

10. Insert the liner into the yellow and black opening behind the two rollers until it hits a stop.



11. Lift the peeler door up to close it.



12. Turn the thumbwheel to the right of the peeler to tighten the liner.
13. Close the top cover on the printer until it latches.

14. Tap **Feed Supply** on the touch screen to advance the label supply. You may need to tap several times until a label dispenses from the printer.
15. Remove the dispensed label. Failure to do so will result in a jam.
16. Close the wrapper module.
17. Tap **Done** on the touch screen.

## Rewinder Accessory

The rewinder accessory can be purchased separately from your distributor, part number *A6200 Rewinder*. The rewinder accessory rewinds the label backing after labels are printed to keep the area around the printer tidy. Spent label backing can accumulate rapidly around a heavily used printer and can jam the printer if it interferes with label liner exiting the printer.

The rewinder weighs 3.2 lbs (1.5 kg).

### Installing the Rewinder

#### To install the rewinder:

1. Prepare a clear space on a flat work surface. Turn off and unplug the printer.
2. Make sure the top cover and wrapper module are closed and latched and that the touch screen is flat against the cover. Turn the printer upside down.



**CAUTION!** To avoid damaging the touch screen, make sure the touch screen is flat against the cover and that the work surface is clear of any objects before turning the printer over.

To avoid damaging the printer, make sure the top cover and wrapper module are closed and latched so that they do not fall open. Unplug power and USB cables so that they do not catch and cause the printer to fall while turning it over.

3. Set the rewinder on the printer so that the screw hole in the bottom of the printer lines up with the screw in the rewinder.



4. Tighten the screw.
5. Attach the cable from the rewinder to the rewinder port on the back of the printer.



6. Turn the entire unit right-side up and plug in the printer.

7. Start the backing of the label roll in the empty spool in the rewinder. See *“Starting a New Roll”* on page 23.



CAUTION! When moving the printer with the rewinder attached, be sure to lift from the cutouts on either side of the rewinder to avoid damage if the attachment is not fully secure.

## Starting a New Roll

Always remove spent backing from the spool before starting another roll. See *“Removing Spent Label Backing”* on page 24.

### To attach the label backing to the rewinder spool:

1. Load the label supply in the printer if you have not already done so. See *“Loading Label Supply”* on page 17.
2. Print labels until approximately six inches of backing is discharged from the printer. (Alternatively, you can press **Feed Supply** on the touch screen to expel label material.)



3. Open the door on the front of the rewinder.

4. Flip down the yellow bar on the spool and insert the end of the label backing into the slot above the bar. Flip the yellow bar back up to secure the backing on the spool.

Insert label backing here.

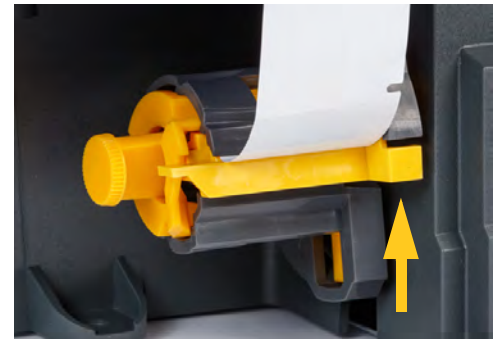

**CAUTION!** Do not tape together partial rolls in the rewinder. Too much label backing accumulating on the spool could damage the motor. Always remove spent material from the spool when starting a new or partial roll of labels.

## Removing Spent Label Backing

Always unload the spool when changing the label supply in the printer.

### To remove spent material from the spool:

1. Use the tear blade to separate spent backing from the label roll.
2. Open the door on the front of the rewinder.
3. Pull out the yellow knob on the left side of the spool. This releases the material and slides it off the spool.
4. Remove the spent material.

# 3 General Operation

## Using the Touch Screen

Use the printer's touch screen to configure settings, check status, and print and wrap labels, among other functions. Touch the screen with your finger to make a selection. The screen is hinged so that you can adjust the viewing angle up or down.

**Note:** Do not use a writing pen or other sharp object. Doing so may mar the touch screen surface.

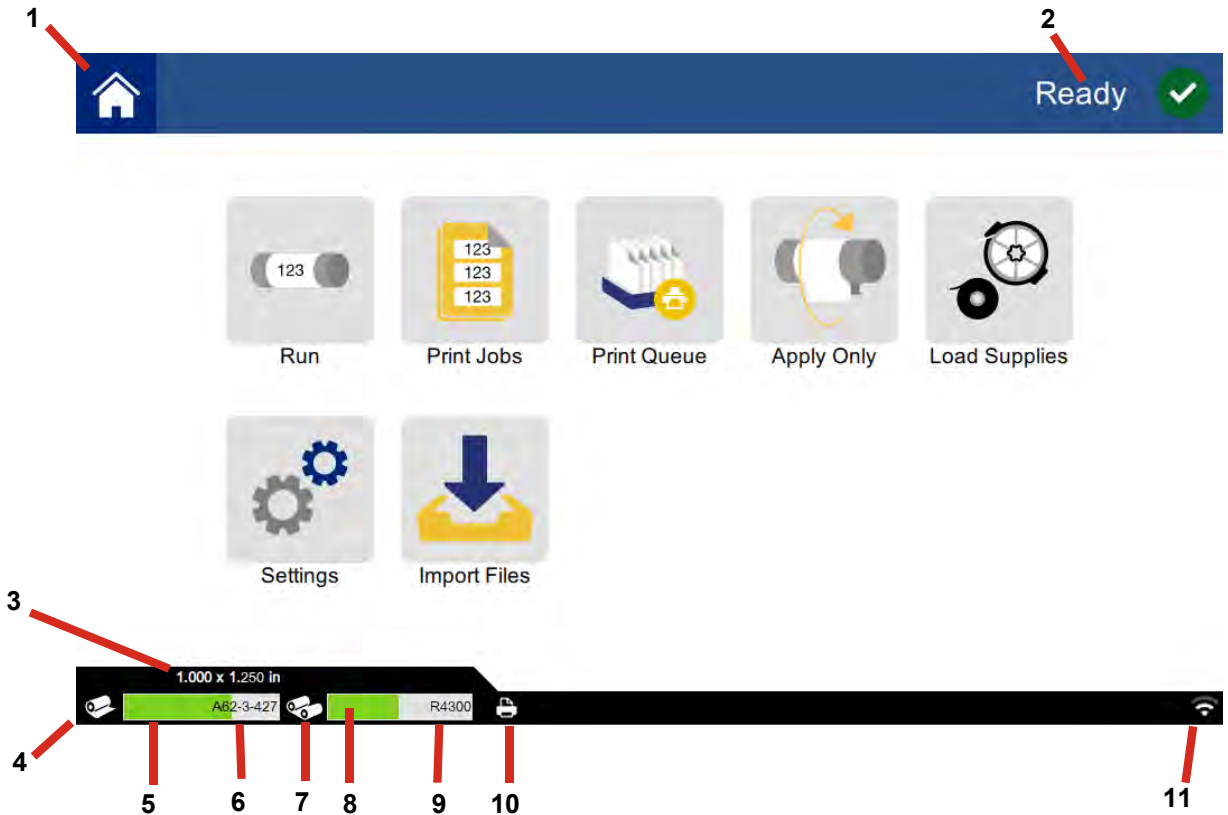

1	Home	7	Ribbon status
2	Printer status	8	Ribbon remaining
3	Supply size	9	Ribbon part number
4	Supply status	10	Print job status
5	Supply remaining	11	Wi-Fi on and signal
6	Supply part number		



## Navigation and Status Bar



Tap the home button at any time to return to the home screen.



While navigating the menus, tap the back button to go back to the previous screen.

The printer and supply status icons in the status bar at the bottom of the home screen provide the following information.

Icon	Meaning
	The text beside this icon indicates the label material installed in the printer.
	The printer cannot read the memory cell on the label supply. Label supply may not be installed, may be installed incorrectly, or the memory cell may be corrupted.
	The printer is ready to print and wrap a label. This icon is only visible when the Printing (run) screen is displayed and a print job is loaded.
	Printing is paused. To resume printing, return to the home screen and tap <b>Run</b> .
 blinking	The printer is receiving data from a computer connected with a USB cable or from the network.

## Material Details

To see detailed information about the label supply and ribbon, click the supply or ribbon part number in the status bar. The *Material Details* screen opens.



To close the *Material Details* screen, click the x in the upper right corner.

## Creating Labels

Create label files using Brady Workstation software. When you first create a label file, you specify the printer. This allows the software to provide features specific to your printer. Also, the software automatically detects the labels installed in the printer. See “*Software for Creating Labels*” on page 11.

For help using the software, refer to the documentation within the software.

## Printing: Quick Start

The primary function of the Wraptor A6200 Wrap Printer Applicator is to print labels for wire identification and wrap them on the wire or cable. However, you can also print a label without wrapping it.

When you print labels to the Wraptor A6200 printer from your labeling software, the printer does not immediately print the labels. The software sends the labels to the printer's internal memory. Because the printer requires an operator to insert a wire or cable for wrapping, or to remove a printed label, the operator must initiate printing at the printer.

### Printing and Wrapping

The process flow is as follows:

#### On your computer:

1. Design labels on your computer using Brady Workstation software.
2. Send your completed labels to the printer with the **Print** command.

#### On the printer:

1. On the home screen, tap **Print Jobs**.
2. Tap the check box for a job to select it and then tap **Add**. 

This places the job into the print queue and displays the Printing (Run) screen.

For details about the Run, Print Jobs, and Print Queue functions on the home screen, and related settings, see *“Running Jobs” on page 33*, *“Managing Print Jobs” on page 29*, and *“Managing the Print Queue” on page 32*.

3. Physically insert a cable or wire into the printer jaws. Push the wire against the trigger bars until the jaws clamp. The trigger bars must be pressed in fully to initiate printing and wrapping, or just wrapping. Hold the wire loosely during wrapping so that the wrapper mechanism can move freely.



**WARNING!** The wrapper mechanism contains hazardous moving parts. Keep fingers and other body parts away.



**CAUTION!** The maximum wire diameter that can be used in the Wraptor A6200 printer, INCLUDING the wire's outer jacket, is 0.25 inch. Exceeding this diameter will jam and potentially damage the machine. If a wire diameter less than 0.06 inch (including wire jacket) is used, the label may not wrap successfully.

### Wrap Quality

Please heed the following tips as not doing so may effect the quality of your wrap:

- Make sure to hold the wires tight and straight during wrapping. Kinked or curved wire may cause spiraling or bubbling.
- Make sure to use the correct size label for the wire you intend to wrap.
- Do not use wire jackets with greasy coatings or the label will not wrap properly.
- Inspect the peel plate area—especially below—to ensure there are no stuck labels.
- Clean rollers to ensure that there is no adhesive build-up. See *“Cleaning the Rollers and Peel Plate”* on page 41 for cleaning and maintenance recommendations.

### Printing Without Wrapping (Print Only)

#### On your computer:

1. Design labels on your computer using Brady Workstation software.
2. Send your completed labels to the printer with the **Print** command.

#### On the printer:

1. On the home screen, tap **Print Jobs**.
2. Tap the check box for a job to select it and then tap **Add**.



This places the job into the print queue and displays the Printing (Run) screen.

For details about the Run, Print Jobs, and Print Queue functions on the home screen, and related settings, see “*Running Jobs*” on page 33, “*Managing Print Jobs*” on page 29, and “*Managing the Print Queue*” on page 32.

3. Press the gray button on the front of the printer to open the wrapper module.
4. Tap **Print Only** on the touch screen.
5. Remove the printed label.
6. Close the wrapper module.

## Wrapping Without Printing (Apply Only)

When you have pre-printed labels, you can use the Wraptor A6200 printer to apply the labels to the wire or cables without printing.

### To apply labels without printing:

1. On the home screen, tap **Apply Only**.
2. Insert the wire into the printer jaws. The printer wraps the pre-printed label onto the wire and the counter increments.



## Printing: Details

When jobs are sent to the printer, they reside in the printer’s memory and must be placed in the print queue. If you have jobs in the queue, you can simply tap *Run* on the home screen to begin printing. Otherwise you must tap *Print Jobs* on the home screen and add jobs to the queue.

### Managing Print Jobs

Tap **Print Jobs** on the home screen to open the *Print Jobs* screen. The *Print Jobs* screen lists files in the printer’s memory or on a USB drive, depending on the *File Location* setting in *Settings*. (See “*File Location*” on page 8.) In order to print these jobs, they need to be placed in the queue.



To add jobs to this list:

- Printer memory: Print from Brady Workstation software with the Wraptor A6200 printer selected. On the printer, *Settings > System Configuration > File Location* must be set to *Internal Memory*.
- USB drive: See “*Transferring Print Jobs Between Printers*” on page 35.



The *Internal Memory* box at the bottom of the screen indicates how much memory is available on the printer. The first number represents the amount of memory available and the second number represents the total memory capacity of the printer. The green bar gives a visual indication of the percent full. The bar turns red when memory is low.

**Finding a Print Job**

If the list of jobs is long, you can find the job that you want faster by sorting or searching. Also, you can change the view to display a list or to display thumbnail images of the first label in the file.

To change the view, tap the **View** button.

	Shows thumbnail images of the first label in each file. The filename and number of labels in the file is shown below the thumbnail. This view is useful to see that you have the correct file.
	Lists files by filename only. The number of labels in the file is shown to the right.

**To scroll through the list:**



Drag your finger up or down on the screen to scroll through the list of files.

**To sort the list:**

1. Tap the **Sort By** button.

2. Tap one of the options to sort the list alphabetically, by date, by number of labels, or by label supply.

**To search for a label file in the list:**

1. Tap the **Search** button. 
2. Use the keyboard displayed on the touch screen to type all or part of a file name to search for. The search is not case sensitive.
3. Tap the enter button. 
4. The list of print jobs displays only files found in the search. To clear the search and display all files again, click the clear button. 

### **Adding a Job to the Queue**

You must add jobs to the queue in order to run them, that is, to print labels and wrap them around a wire or cable.

**To add a job to the queue:**

1. Find the job you wish to add to the queue and tap the check box for that print job.
2. Tap the **Add** button.  (If the *Add* button is not visible when you have multiple jobs selected, then you need to enable the print queue. To do so, go to **Settings > Print Queue > Enable Print Queue**. See “*Print Queue*” on page 35.)



The printer runs the print job and displays the Printing screen. See “*Running Jobs*” on page 33.

**Tip:** If you turn on **Auto Queue Job** in **Settings > Print Queue**, then you don’t have to manually add jobs to the queue.

### **Deleting a Job**

Deleting a job removes the label file from the printer’s memory or from the USB drive depending on your *File Location* setting.

**To delete a print job:**

1. Find the job you wish to delete and tap the check box for that print job. You cannot delete jobs that are in the print queue. Jobs that are in the print queue have this symbol rather than a check box next to them.   
To remove jobs from the print queue, see “*Print Queue*” on page 35.
2. Tap the **Delete** button. 

## Managing the Print Queue

A print job must be in the queue in order to print it. Jobs print in the order that they are listed in the queue. Use the *Print Queue* screen to change the order of jobs in the queue or to cancel print jobs. Tap **Print Queue** on the home screen to display the *Print Queue* screen.



You can only have one job at a time in the queue unless you enable the print queue in Settings > Print Queue. See “*Print Queue*” on page 35.

To add a job to the queue, use the *Print Jobs* screen. See “*Adding a Job to the Queue*” on page 31.

To cancel a job or change the order, tap a print job and then tap one of the following buttons.

Button	Description
	<b>Cancel One.</b> Removes the selected job from the queue.
	<b>Cancel All.</b> Removes all jobs from the queue.
	<b>Move Up.</b> Moves the selected print job up one position in the queue.
	<b>Move Down.</b> Moves the selected print job down one position in the queue.

## Running Jobs

Tap **Run** on the home screen to begin printing and wrapping the first job in the print queue. The touch screen displays the first label in the first job as well as controls for moving between labels, a mode indicator, and a counter of labels printed and wrapped.

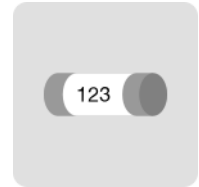

**CAUTION!** If the wrong label material for the file is in the printer, a message is displayed. Use caution when overriding this warning message. The label size loaded in the printer may not be appropriate for the print file and will generate scrap.

**To print the label and wrap a wire:** Insert the wire into the printer jaws. The printer prints the label and wraps it on the wire. The display advances automatically to the next label. For more detail see *“Printing: Quick Start” on page 27.*

The following table describes the controls and information on the touch screen when running a print job.

Button	Description
	Goes to the next label. (Not available if the print file contains only one label.)
	Goes to the previous label. (Not available if the print file contains only one label.)
	Goes to the last label in the file. (Not available if the print file contains only one label.)
	Goes to the first label in the file. (Not available if the print file contains only one label.)



Button	Description
<b>Next:</b>	Shows whether the printer advances to the next label automatically or manually (see “ <i>Advance to Next Label</i> ” on page 8 for details).
<b>Label</b>	Displays the current position in the label file as well as the total number of labels. Tap the current label number (within a rectangle) to jump to a particular label. A keypad opens. Tap the label number on the keypad and then tap the enter button. 
<b>Close Job</b>	If the printer is set to repeat printing the same file, click <b>Close Job</b> to stop printing this file and go to the next file in the print queue. For more information about the <i>Close Print Job When Completed</i> setting, see “ <i>Print Queue</i> ” on page 35.
<b>Print Only</b>	Print the label, but do not apply it to the wire or cable. Open the wrapper module before printing and remove the label immediately after printing.
<b>Reset Count</b>	The number to the left indicates the number of labels wrapped. Tapping <b>Reset Count</b> resets the number to zero.

## Settings

The following sections discuss settings related to printing and the print queue. For other settings see “*Printer Settings*” on page 7 and “*Connecting the Printer*” on page 12.

### Print Adjustments

To set print adjustments, tap **Settings** on the home screen, then tap **Print Adjustments**.

These settings will be used on all print jobs. If you want to change them just for one job, be sure to reset to the default settings when you are done. To do so, tap **Reset Default**. Measurement units are in inches or millimeters depending on what units are set in *Settings > System Configuration > Measurement Units*.

- Note:** Using the Batch Print tool in Brady Workstation software, you can save printer position adjustments with the label file so that you do not have to change the horizontal and vertical offsets each time you print that file.
- **Print Energy:** Use the slider to adjust for darker or lighter printing. Print a label to test the setting.
  - **Feed to Wire:** Use the slider to adjust how much the printer peels the label before wrapping the wire. The zero (middle) position on the slider represents the factory setting. Adjustments are relative to the factory setting. This is useful for braided wires because there is less contact area for the labels to adhere to. Setting this too high can cause labels to jam.
  - **Wrap Count:** Use the slider to change the number of times that the wrapping mechanism moves around the wire when wrapping a label.
  - **Cycles:** Displays the number of times the printer has printed or wrapped a label on a wire or cable. The cycle count cannot be edited or reset. This value is used to determine when to perform maintenance on the printer.

## Print Queue

To change print queue settings, tap **Settings** on the home screen, then tap **Print Queue**.

Settings for the print queue are either on or off. Tap the switch to change the setting. If the switch is red, it is off. If the switch is green, it is on.



Set the following options. You may need to swipe up to see all of them.

- **Enable Print Queue:** If this setting is off, only one job at a time can be added to the print queue.
- **Remove Print Job from Queue when Closed:** Removes the print job from the queue when the job is closed. Job files are closed either when you tap the *Close Job* button on the *Printing* screen, or if the job is set to automatically close when completed. When removed from the queue, the job is still available from the *Print Jobs* screen.
- **Delete Print Job when Closed:** Delete the current print job when it is closed. Job files are closed either when you tap the *Close Job* button on the *Printing* screen, or if the job is set to automatically close when completed. Jobs are not deleted when you cancel them from the print queue.
- **Prompt for Delete Confirmation:** This is only visible when *Delete Print Job when Closed* is turned on. Turn this on to see a confirmation message before the printer automatically deletes a print job when it closes.
- **Load Last Job:** If this setting is on, the last job that was running at the time the printer was turned off remains in the print queue so that you can continue printing.
- **Resume Print Job at Last Label Number:** When opening a print job that contains multiple labels, the printer can start at label one, or it can start where you left off. Turn this setting on to resume where you left off the last time the job was closed or the printer was turned off while running this job.
- **Auto Queue Job:** Turn this on to automatically add jobs to the print queue when they are sent to the printer. If this is off, then you have to use the *Print Jobs* button on the home screen to add jobs to the queue.
- **Close Print Job When Completed:** Turn this on to automatically advance to the next print job in the queue after printing the last label in the file.



## Transferring Print Jobs Between Printers

If you have one printer that has access to Brady Workstation software, and another that does not, use a USB drive to transfer the print jobs.

**Note:** You cannot transfer print jobs from a different model Wraptor family printer to the Wraptor A6200 printer.

### To transfer a print job between printers:

1. On the printer connected to a computer with Brady Workstation software, insert a USB drive into the type A USB port. (See *“Printer Components”* on page 6.)
2. Set the printer to use the USB port rather than internal memory.
  - a. On the home screen, tap **Settings**, then tap **System Configuration**.

- b. Tap **File Location**, then tap **External USB**.
  - c. Tap the home button to return to the home screen. 
3. Use Brady Workstation software to send the label file to the printer. The file is placed on the USB drive rather than in the printer's memory.
4. Remove the USB drive.
5. On the printer that you wish to transfer the job to, insert the USB drive.
6. Set the printer to use the USB port rather than internal memory.
  - a. On the home screen, tap **Settings**, then tap **System Configuration**.
  - b. Tap **File Location**, then tap **External USB**.
  - c. Tap the home button to return to the home screen. 
7. Tap **Print Jobs** and print the job as usual. See "On the printer:" on page 27.

## Import Print Jobs

If you want to create labels on a computer that is not connected to the printer, use BradyWorkstation software to create the labels and a USB drive to import them.

1. Create the labels with Brady Workstation software and save to a .prn file. (See the help in the software for instructions.)
2. Copy the .prn file to a USB drive.
3. Insert the USB drive into the USB host port on the back of the printer.
4. On the home screen, tap **Import Files**.
5. Tap **Print Jobs**.
6. Choose the print jobs to import or use *Select All*.
7. Tap the home button to return to the home screen , if desired. Otherwise, a message will display on the *Import Print Jobs* screen when the import is complete and the print jobs can be viewed.

## Running a File Using a Barcode Scanner

In some situations you may wish to provide operators a way of printing and wrapping labels without having to select the correct label file. You can code the name of the label file into a barcode and provide operators the barcode on a work order, for example.

## Set Up the Scanner

Connect a USB scanner to the Wraptor A6200 printer. We recommend the Brady Code Reader scanner configured for USB.

- Set up the scanner for at least a 30ms inter-character delay. This will ensure that the printer receives all characters transmitted by the barcode scanner. The following barcodes will set up the Code Reader scanner to use a 40ms inter-character delay:



**40-ms Intercharacter  
Delay**



**Save Settings**

- Add an *Enter* suffix to the Code Reader scanner. For other scanners, enter the equivalent of a carriage return and line feed in keyboard mode.

## Set Up the Label Files and Barcodes

Make sure that the label files to print are all downloaded to the printer, either in printer memory or on a USB drive. Create and provide barcodes to operators.

### To put the label files in printer memory:

- Make sure the printer is set to use internal memory (*Settings > System Configuration > File Location*).
- Use your labeling software to create and send label files to the printer.

### To create the barcodes:

- Create a barcode image containing the name of the label. Use any barcode symbology that is supported by your barcode scanner.  
Create a barcode for each label file.
- Provide the correct barcode to operators. One way to do this is to set up your system to include the appropriate barcode on work orders.

## Print from a Barcode

### To print and wrap labels:

- On the printer's touch screen, tap either **Run** or **Print Jobs**.
- Scan the print job barcode. If everything is set up correctly, it will open the print job specified by the barcode.
- Insert a wire or cable into the printer jaws to print and wrap as you normally would. (For more information see "*Printing: Quick Start*" on page 27 and "*Wrap Quality*" on page 28.)

## 4 Maintenance

---

The Wraptor™ A6200 printer requires periodic maintenance to ensure trouble-free operation. The system uses the *Cycle* count to determine when maintenance is required. A maintenance reminder is displayed when the cycle interval is reached.

### Displaying System Information

The *About* screen displays version numbers for various components of the system. Check the *Firmware driver* version when considering a firmware upgrade.

**To view system information:**

1. From the home screen, tap **Settings**. 
2. Tap **About**. Additional information available by tapping *Details* is primarily for use when instructed by Brady Support.

### Installing an Upgrade

Upgrades to firmware (printer system software) are available online. For information on how to locate the current firmware version on your printer, see “*Displaying System Information*” on page 38.



**CAUTION!** Do not interrupt printer power during an upgrade.

**To upgrade firmware:**

1. On a computer, go to the technical support website for your region. See “*Technical Support and Registration*” on page iv.
2. Find firmware updates.
3. Find the most recent Wraptor A6200 firmware upgrade.
4. Download the firmware.
5. Save the downloaded file to a USB drive.
6. Connect the USB drive to the USB port on the printer. The printer recognizes the upgrade file and displays a message on the touch screen.

7. Follow the instructions on the touch screen. When the upgrade is complete, the printer restarts.

## Updating Y and B Values

Y and B values are included in a database of label and ribbon part information that enables the printer to work optimally with various supplies.

Update Y and B values periodically to make sure the printer has data for any new label supplies. Also, update if you have ordered a custom label supply from Brady and it came with new Y and B values.

You do not need to know your current database version. The printer displays a confirmation message showing the version numbers during the import process.

### To update Y and B values:

1. On a computer, go to the technical support website for your region. See “*Technical Support and Registration*” on page iv.
2. Find firmware updates and the most recent Wraptor™ A6200 database (Y and B) update.
3. Download the database update.
4. Save the downloaded file to a USB flash drive.
5. Connect the USB flash drive to the USB host port on the printer.
6. On the home screen, tap **Import Files**. 
7. Tap **Y & B Files**. Follow the instructions on the screen to complete the import. The new values take effect as soon as the import completes.

## Cleaning

Perform the following cleaning routine when prompted to do so or at least every 5,000 labels to keep the Wraptor A6200 printer running at optimal performance. You can find the cycle count on the touch screen in *Settings > Print Adjustments > Cycles*.

Have the following supplies on hand to clean the tarp, print head, rollers, and sensors.

- cotton swabs
- isopropyl alcohol

### Cleaning the Tarp

#### To clean the tarp:

1. Turn off the printer and unplug it.
2. Push the gray button on the front of the printer to open the wrapper module.

3. Dip a cotton swab in isopropyl alcohol.
4. Rotate the wrapper mechanism so that the tarp is facing toward the printer. Push the grooved roller shown below towards the tarp. This moves the tarp away from the lower ridged roller so you can access the tarp for cleaning.

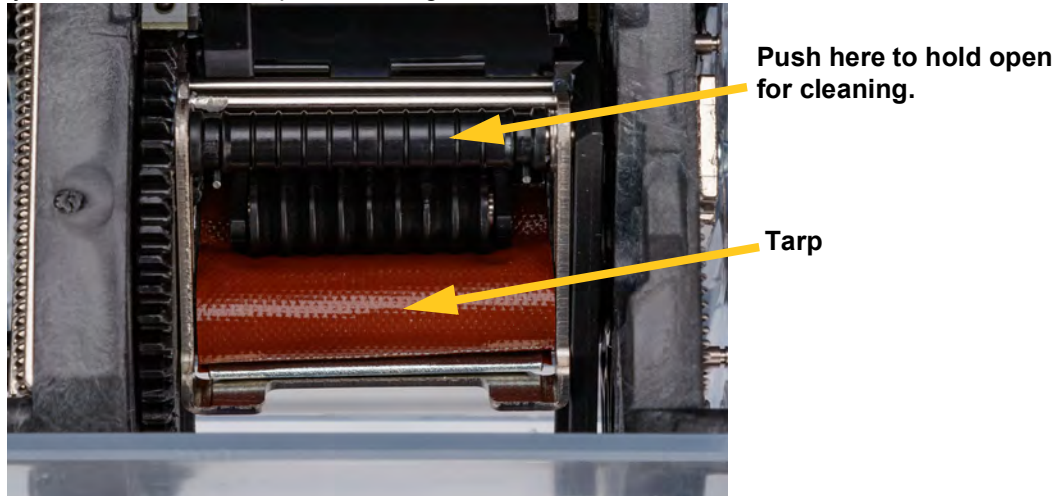

5. Using the moistened swab, clean the tarp. Make sure the tarp is free of dust, debris and label adhesive build-up.



**CAUTION!** Failure to remove adhesive build-up will cause labels to jam on the tarp.

6. Close the wrapper module.

## Cleaning the Print Head

### To clean the print head:

1. Turn off the printer and unplug it.
2. Open the top cover.
3. Remove the ribbon to expose the print head. See *“Loading Ribbon” on page 15.*
4. Dip a cotton swab in the isopropyl alcohol.

- Using the moistened swab, thoroughly clean the top surface of the print head.

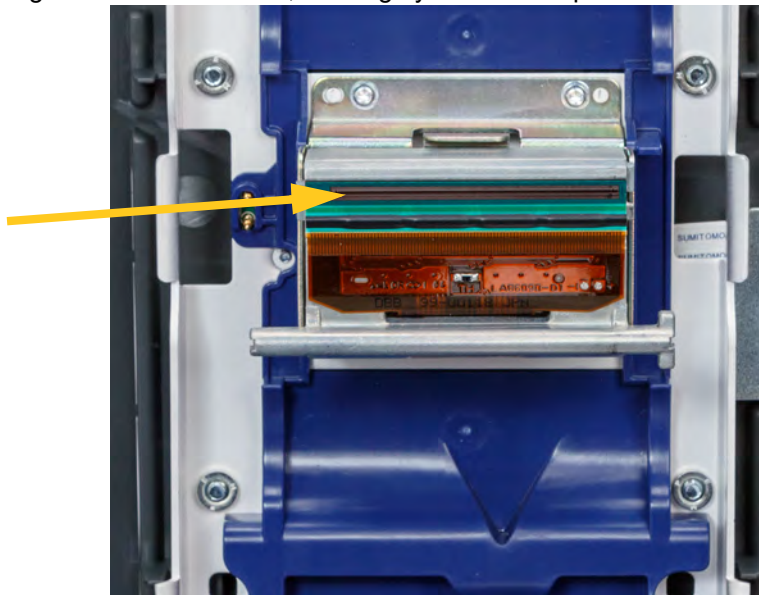

- Replace the ribbon and close the cover.

## Cleaning the Rollers and Peel Plate

Rollers move and guide the label supply through the printer. Also see *“Cleaning the Tarp”* on page 39.

### To clean the rollers:

- Turn off the printer and unplug it.
- Press the gray button on the front of the printer to open the wrapper module.
- Remove the label supply. See *“Loading Label Supply”* on page 17.
- Press the yellow button to the lower left of the peeler to open the peeler door.

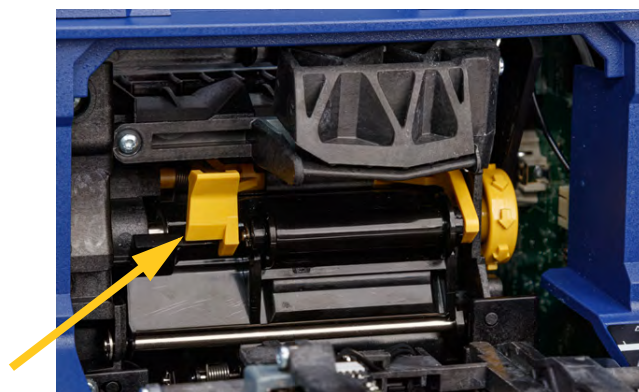

peeler door closed

- Dip a cotton swab in the isopropyl alcohol.



6. Using the moistened swab, clean the three rollers shown below. Make sure each roller is free of dust, debris and label adhesive. Use as many swabs as necessary so that you are always using a fairly clean swab.

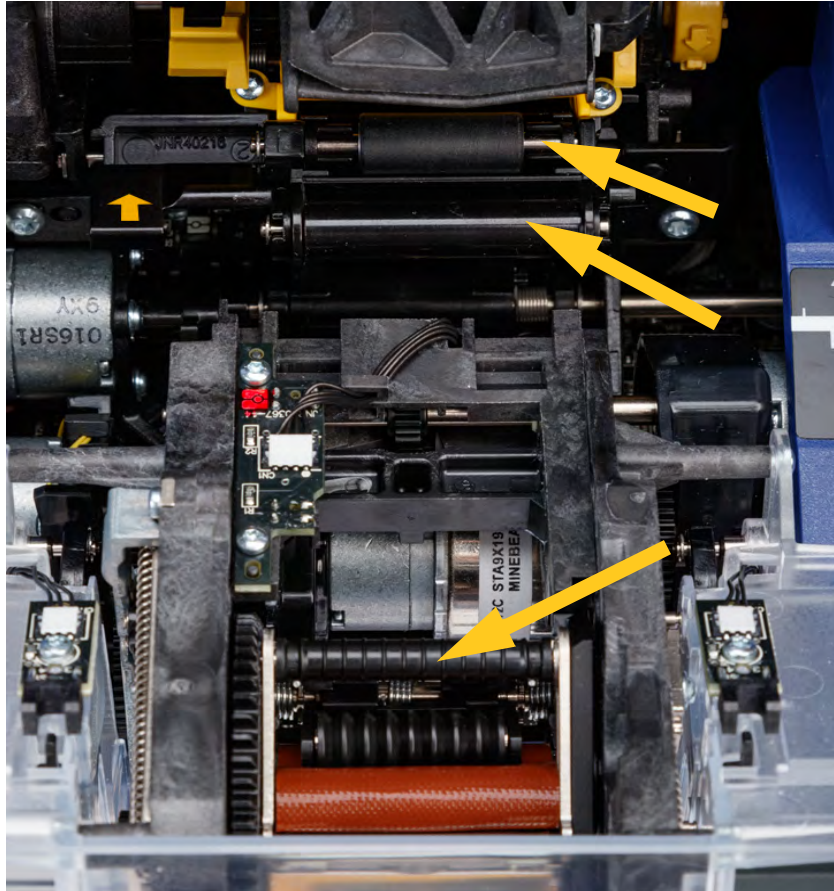

7. Dip a clean swab in isopropyl alcohol and clean the edge of the peel plate.



8. Close the wrapper module and open the top cover.
9. Dip a clean cotton swab in isopropyl alcohol.

10. Use the moistened swab to clean the platen roller.

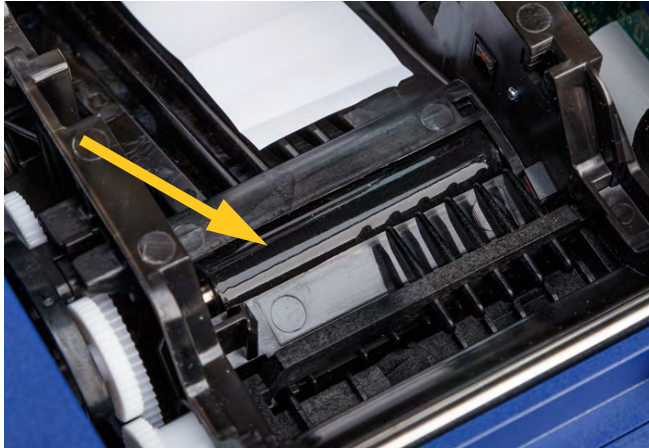

## Cleaning the Sensors

The printer contains the following sensors that should be cleaned every six months to one year.

- Label notch sensor in the printer chassis
- Ribbon out sensor in the printer chassis
- Smart cell contacts in the cover behind the ribbon
- Trigger sensors on the wrapper module

### To clean the sensors:

1. Turn off the printer and unplug it.
2. Open the top cover and the wrapper module. (Press the gray button on the front of the printer to release the wrapper module.)
3. Remove the ribbon and label supply. See *“Loading Ribbon”* on page 15 and *“Loading Label Supply”* on page 17.

4. Clean the **label notch sensor** in the printer chassis with a clean swab dipped in isopropyl alcohol.

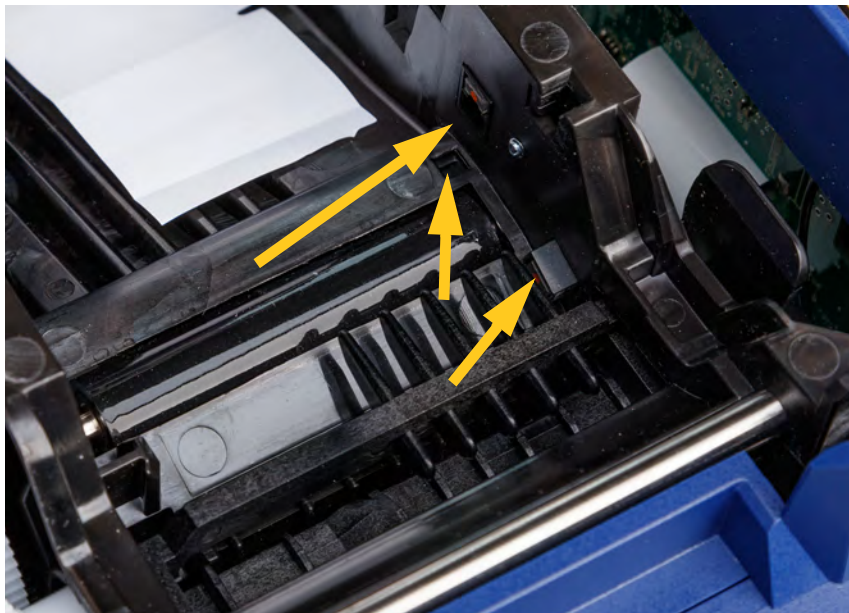

5. Clean the **ribbon out sensor** in the printer chassis with a clean swab dipped in isopropyl alcohol.



6. Clean the smart cell contact in the top cover with a clean swab dipped in isopropyl alcohol.

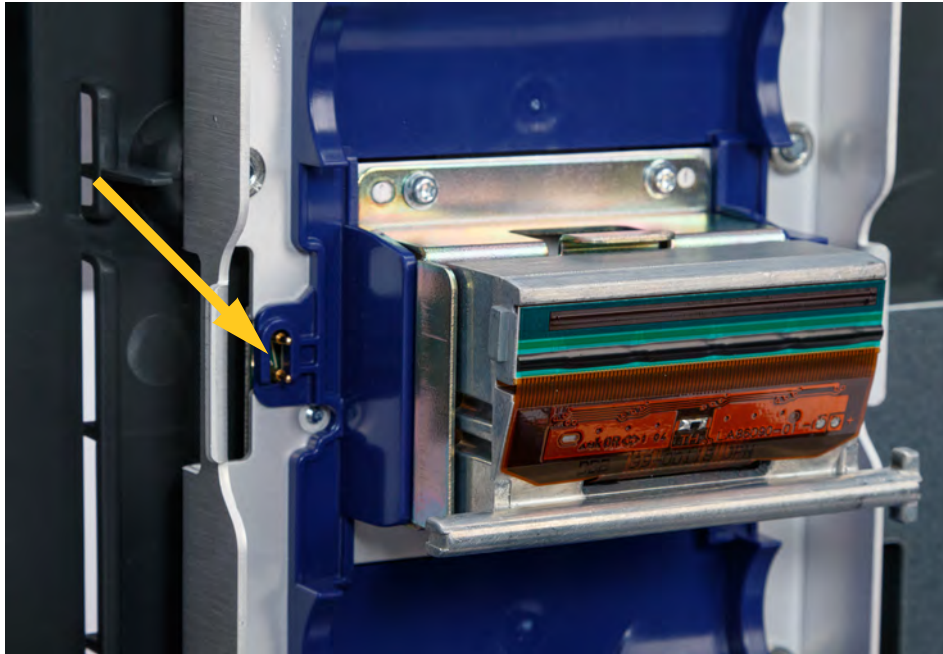

7. Clean the **trigger sensors**, located on either side of the wrapper mechanism with a clean swab dipped in isopropyl alcohol.

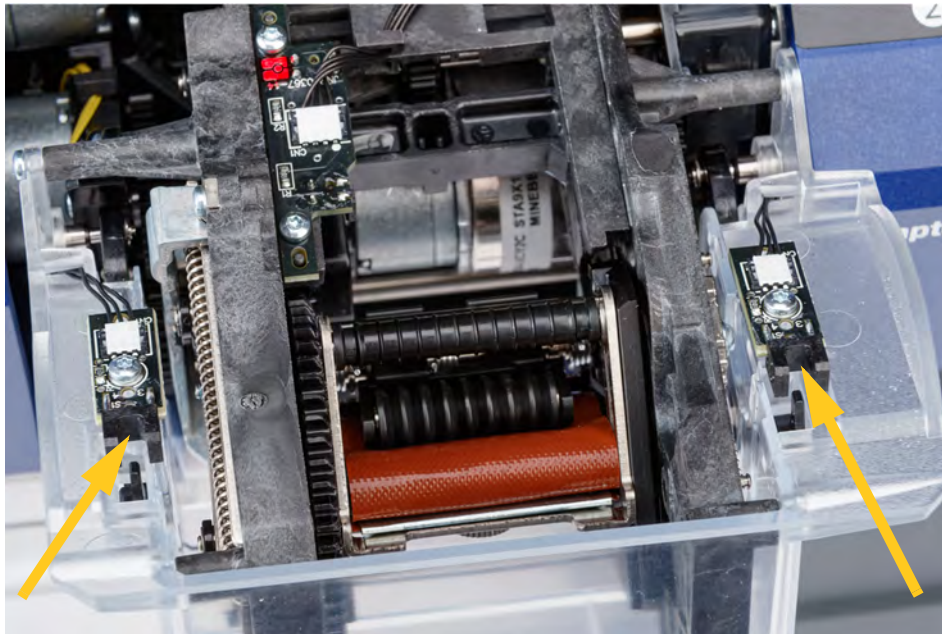

8. Reload ribbon and labels, then close the top cover and wrapper module.

## Cleaning the Fan Filter



CAUTION! You must clean the fan filter of accumulated dust.

### To clean the fan filter:

1. Use a tweezers or flat-head screwdriver to pull the grate off the fan located on the back of the printer.
2. Remove the filter.
3. Clean the filter using either of these methods:
  - Blow clean air through it.
  - Wash it with a mild detergent and allow it to dry.
4. Replace the clean filter.
5. Snap the grate back into place over the fan.

The fan filter is a replacement part that you can order.

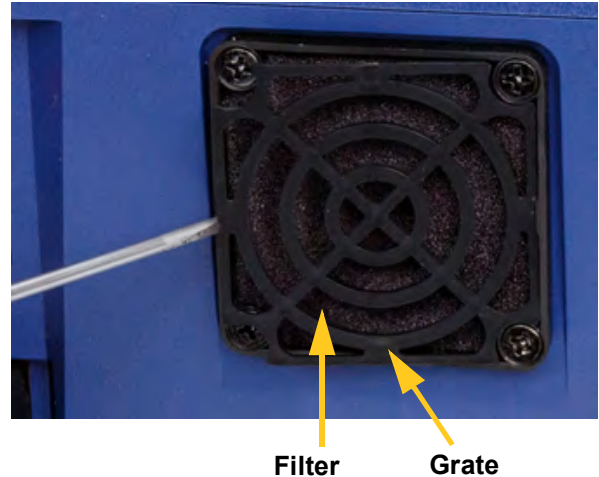

## 5 Troubleshooting

---

If you encounter a problem while using the printer, see the following sections for help troubleshooting the issue.

- *“Wrap is not applied correctly” on page 47*
- *“Labels jam on the tarp” on page 49*
- *“Label material jams within the printer” on page 49*
- *“Label material feeds incorrectly” on page 49*
- *“Print quality is poor” on page 50*
- *“Print is too light” on page 50*
- *“Nothing happens when I place a wire in the jaws” on page 51*
- *“No print jobs are in the printer” on page 51*

### Wrap is not applied correctly

**Problem:** The wrap did not fully adhere to the label.

**Solutions:**

- The wrapping mechanism may not be revolving around the wire or cable enough times to adhere the full length of the label. On the touch screen, tap **Settings**, then **Print Adjustments**, then **Wrap Count** and increase the number of times the wrapper moves around the wire.

- Labels may be stuck in the peeler area or to the rollers below the peel plate. Remove stuck labels and any adhesive residue. See *“Cleaning the Rollers and Peel Plate”* on page 41.

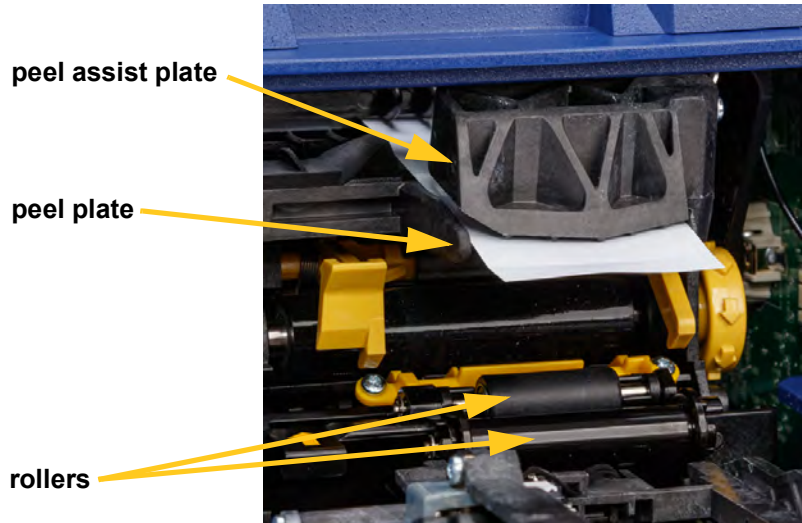

- Make sure the label supply is loaded correctly and is not wrapped around the rollers. See *“Loading Label Supply”* on page 17
- The label notch sensors may need to be cleaned. See *“Cleaning the Sensors”* on page 43.
- The grooved roller may be dirty or have adhesive residue. On the touch screen, tap **Load Supplies** and then tap **Clear Jam**. Tap **Feed Supply** and observe whether the labels flow freely on the grooved roller. If not, clean the roller with isopropyl alcohol and a cotton swab. See *“Cleaning the Rollers and Peel Plate”* on page 41

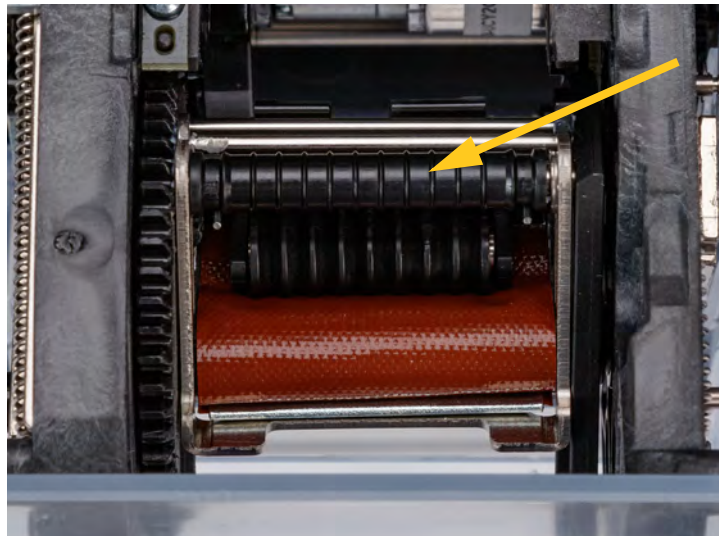

## Labels jam on the tarp

**Problem:** Labels jam or fold on the wrapper rather than adhering properly to the wire.

**Solutions:**

- Check the *Feed to Wire* setting and return it to zero if it is set higher. See “*Print Adjustments*” on page 34.
- The tarp may have adhesive residue on it. See “*Cleaning the Tarp*” on page 39.
- Examine the tarp. If it has a white horizontal line or cracks, it needs to be replaced. Contact Technical Support. See “*Technical Support and Registration*” on page iv
- The rollers may have debris on them. See “*Cleaning the Rollers and Peel Plate*” on page 41.

## Label material jams within the printer

**Problem:** Label material doesn't feed properly through the printer and jams.

**Solutions:**

- Make sure the label supply is loaded correctly and is not wrapped around the rollers. See “*Loading Label Supply*” on page 17
- The rollers may be dirty or contaminated with adhesive. See “*Cleaning the Rollers and Peel Plate*” on page 41.
- Labels may be stuck in the peeler area or to the rollers below the peel plate. Remove stuck labels and any adhesive residue. See “*Cleaning the Rollers and Peel Plate*” on page 41.
- The tarp may be dirty or contaminated with adhesive. See “*Cleaning the Tarp*” on page 39.
- One of the sensors may be dirty. See “*Cleaning the Sensors*” on page 43.
- On the touch screen, tap **Load Supplies** and then tap **Clear Jam**. Follow the instructions on the screen to clear the jam.

## Label material feeds incorrectly

**Problem:** Rollers move, but the label material stays in place, the label material has slack in it, or the label material seems to feed backwards. An error message states that the peeler door is open.



**Solution:**

- Close the peeler door. See *“Loading Label Supply”* on page 17.



## Print quality is poor

**Problem:** Printing appears smudged or ink is inconsistently applied.

**Solutions:**

- The print head may be dirty. See *“Cleaning the Print Head”* on page 40.
- If print looks stretched, the rollers may have debris or adhesive on them. See *“Cleaning the Rollers and Peel Plate”* on page 41.
- If the print looks grainy or overlapped, the platen roller may be dirty. See *“Cleaning the Rollers and Peel Plate”* on page 41
- The print head may be worn and need to be replaced. Call Technical Support, see *“Technical Support and Registration”* on page iv.

## Print is too light

**Problem:** Print is too light.

**Solutions:**

- Tap **Settings**, then **Print Adjustments**, then **Print Energy** and increase the darkness.

## Nothing happens when I place a wire in the jaws

**Problem:** I sent a file to the printer, but when I put a wire in the jaws, nothing happened.

**Solutions:**

- When inserting the wire, make sure that the trigger bars are pressed in fully. See *“Printing and Wrapping”* on page 27.
- Make sure the print job is added to the queue and that the job is running. See *“Printing: Details”* on page 29. Alternatively, turn the *Auto Queue Job* setting on so that jobs are automatically placed in the queue when received. See *“Print Queue”* on page 35.
- The trigger sensors may need to be cleaned. See *“Cleaning the Sensors”* on page 43

## No print jobs are in the printer

**Problem:** I printed a file to the Wraptor A6200 printer from Brady Workstation software, but when I tap *Print Jobs* on the touch screen, no jobs are listed.

**Solutions:**

- Make sure the file location is set to *Internal Memory*. See *“File Location”* on page 8.
- Make sure the communication settings are correct. See *“Connecting the Printer”* on page 12.

# A Regulatory Compliance

---

## Agency Compliance and Approvals

### United States

#### *FCC Notice*

**Note:** This equipment has been tested and found to comply with the limits for a Class A digital device, pursuant to part 15 of the FCC Rules. These limits are designed to provide reasonable protection against harmful interference when the equipment is operated in a commercial environment. This equipment generates, uses, and can radiate radio frequency energy and, if not installed and used in accordance with the instruction manual, may cause harmful interference to radio communications.

Operation of this equipment in a residential area is likely to cause harmful interference in which case the user will be required to correct the interference at his own expense.

Changes or modifications not expressly approved by the party responsible for compliance could void the user's authority to operate the equipment.

This device complies with Part 15 of the FCC Rules. Operation is subject to the following two conditions: (1) This device may not cause harmful interference and, (2) this device must accept any interference received, including interference that may cause undesired operation.

### Canada

Innovation, Science and Economic Development (ISED)

Canada ICES-003:

CAN ICES-3 (A)/NMB-3(A)

### Mexico

IFETEL notice: La operación de este equipo está sujeta a las siguientes dos condiciones: (1) es posible que este equipo o dispositivo no cause interferencia perjudicial y (2) este equipo o dispositivo debe aceptar cualquier interferencia, incluyendo la que pueda causar su operación no deseada.

## Europe



**WARNING!** This is a Class A product. In a domestic environment, this product may cause radio interference in which case the user may be required to take adequate measures.



### Waste Electrical and Electronic Equipment Directive

In accordance with the European WEEE Directive, this device needs to be recycled in accordance with local regulations.

### RoHS Directive 2011/65/EU, 2015/863/EU

This product is CE marked and complies with the European Union's Directive 2011/65/EU OF THE EUROPEAN PARLIAMENT AND OF THE COUNCIL of 8 June 2011 on the restriction of the use of certain hazardous substances in electrical and electronic equipment.

EU Directive 2015/863 of 31 March 2015 amends Annex II to Directive 2011/65/EU of the European Parliament and of the Council as regards the list of restricted substances.

### Batteries Directive 2006/66/EC



This product contains a lithium coin cell battery. The crossed-out wheeled bin shown to the left is used to indicate 'separate collection' for all batteries and accumulators in accordance with European Directive 2006/66/EC. Users of batteries must not dispose of batteries as unsorted municipal waste. This Directive determines the framework for the return and recycling of used batteries and accumulators that are to be collected separately and recycled at end of life. Please dispose of the battery according to your local regulations.

### Notice to Recyclers

#### To remove the lithium coin cell battery:

1. Disassemble printer and locate the lithium coin cell battery located on the main circuit board.
2. Using a small screwdriver, pry the battery from its holder and remove the battery from the board. Dispose of in accordance with local regulations.

## Turkey

Turkish Ministry of Environment and Forestry

(Directive on the Restriction of the use of certain hazardous substances in electrical and electronic equipment).

Türkiye Cumhuriyeti: EEE Yönetmeliğine Uygundur

## China

China RoHS Hazardous Substance Table related to this product is available at [www.bradyid.com/A6200compliance](http://www.bradyid.com/A6200compliance).

## Wireless Regulatory Information

*Applies to the Wi-Fi radio module only included in printer models that support wireless communication.*

Regulatory markings, subject to country certification, are applied to host printer signifying Wi-Fi (radio) approvals have been obtained.



**WARNING!** Operation of the device without regulatory approval is illegal.

Radio protocol	WLAN IEEE 802.11b/g/n
RF Operating Frequency	2.4 – 2.495 GHz
RF Output Power	< +20dBm EIRP (100mW)
Antenna Type \ Antenna Gain	PCB trace antenna \ -3.06 dBi
Environmental Operation	-40 to 85° C (-40° to 185° F) <b>Note:</b> Be mindful of the maximum operating temperatures for the printer. See “ <i>Environmental Ranges</i> ” on page 2.
Environmental Storage	-55 to 125° C (-67° to 257° F) <b>Note:</b> Be mindful of the maximum storage temperatures for the printer. See “ <i>Environmental Ranges</i> ” on page 2.

## United States

**Note:** This equipment has been tested and found to comply with the limits for a Class A digital device, pursuant to part 15 of the FCC Rules. These limits are designed to provide reasonable protection against harmful interference when the equipment is operated in a commercial environment. This equipment generates, uses, and can radiate radio frequency energy and, if not installed and used in accordance with the instruction manual, may cause harmful interference to radio communications.

Operation of this equipment in a residential area is likely to cause harmful interference in which case the user will be required to correct the interference at own expense.

Changes or modifications not expressly approved by the party responsible for compliance could void the user’s authority to operate the equipment.

This device complies with Part 15 of the FCC Rules. Operation is subject to the following two conditions: (1) This device may not cause harmful interference and, (2) this device must accept any interference received, including interference that may cause undesired operation.

**Co-located statements:** To comply with FCC RF exposure compliance requirement, the antenna used for this transmitter must not be co-located or operating in conjunction with any other transmitter/antenna except those already with radio module filing.

**RF exposure guidelines:** The radiated output power of this device is far below the radio frequency exposure limits. Nevertheless, to avoid the possibility of exceeding radio frequency exposure limits for an uncontrolled environment, a minimum 20cm distance should be maintained from Wi-Fi radio module PCB antenna (internal) to the head, neck, or body during normal operation.

## Canada

Innovation, Science and Economic Development (ISED)

CAN ICES-3 (A)/NMB-3(A)

This device complies with Industry Canada's license-exempt RSSs. Operation is subject to the following two conditions:

1. This device may not cause interference; and
2. This device must accept any interference, including interference that may cause undesired operation of the device.

**Co-located statements:** To comply with FCC RF exposure compliance requirement, the antenna used for this transmitter must not be co-located or operating in conjunction with any other transmitter/antenna except those already with radio module filing.

**RF exposure guidelines / Important note:** This equipment complies with IC radiation exposure limits set forth for an uncontrolled environment. This equipment should be installed and operated with minimum distance 20cm between the radiator and your body.

**Note Importante:** Déclaration d'exposition aux radiations: Cet équipement est conforme aux limites d'exposition aux rayonnements IC établies pour un environnement non contrôlé. Cet équipement doit être installé et utilisé avec un minimum de 20cm de distance entre la source de rayonnement et votre corps.

## Mexico

IFETEL notice:

"La operación de este equipo está sujeta a las siguientes dos condiciones: (1) es posible que este equipo o dispositivo no cause interferencia perjudicial y (2) este equipo o dispositivo debe aceptar cualquier interferencia, incluyendo la que pueda causar su operación no deseada."

## European Union

This is a Class A product. In a domestic environment, this product may cause radio interference in which case the user may be required to take adequate measures.

Radio Equipment Directive (RED) 2014/53/EC

- a. Frequency band(s) in which the radio equipment operates; 2.401GHz to 2.483GHz

- b. Maximum radio-frequency power transmitted in the frequency band(s) in which the radio equipment operates; < +20dBm EIRP (100mW)

## **International**

The Wi-Fi radio module used in Brady host printers comply with internationally recognized standards covering human exposure to electromagnetic fields, i.e. EN 62311 "Assessment of electronic and electrical equipment related to human exposure restrictions for electromagnetic fields (0 Hz - 300 GHz)".

## **Japan**

MIC \ TELECOM: 006-000263

当該機器には電波法に基づく、技術基準適合証明等を受けた特定無線設備を装着している。

## B Licensing

---

### End User License Agreement for Microsoft Windows CE<sup>®</sup>

You have acquired a device that includes software licensed by Brady Worldwide, Inc. from Microsoft Licensing or its affiliates (“MS”). Those installed software products of Microsoft origin, as well as associated media, printed materials, and “online” or electronic documentation (“SOFTWARE”) are protected by international intellectual property laws and treaties. The SOFTWARE is licensed, not sold. All rights reserved.

IF YOU DO NOT AGREE TO THIS END USER LICENSE AGREEMENT, DO NOT USE THE DEVICE OR COPY THE SOFTWARE. INSTEAD, PROMPTLY CONTACT BRADY WORLDWIDE, INC. FOR INSTRUCTIONS ON RETURN OF THE UNUSED DEVICE FOR A REFUND. **ANY USE OF THE SOFTWARE, INCLUDING BUT NOT LIMITED TO USE ON THE DEVICE, WILL CONSTITUTE YOUR AGREEMENT TO THIS END USER LICENSE AGREEMENT (OR RATIFICATION OF ANY PREVIOUS CONSENT).**

**GRANT OF SOFTWARE LICENSE:** This End User License Agreement grants you the following license:

You may use the SOFTWARE only on the DEVICE.

**NOT FAULT TOLERANT.** THE SOFTWARE IS NOT FAULT TOLERANT. BRADY WORLDWIDE, INC. HAS INDEPENDENTLY DETERMINED HOW TO USE THE SOFTWARE IN THE DEVICE, AND MS HAS RELIED UPON BRADY WORLDWIDE, INC. TO CONDUCT SUFFICIENT TESTING TO DETERMINE THAT THE SOFTWARE IS SUITABLE FOR SUCH USE.

NO WARRANTIES FOR THE SOFTWARE. **The SOFTWARE is provided “as is” and with all faults. THE ENTIRE RISK AS TO SATISFACTORY QUALITY, PERFORMANCE, ACCURACY, AND EFFORT (INCLUDING LACK OF NEGLIGENCE) IS WITH YOU. ALSO, THERE IS NO WARRANTY AGAINST INTERFERENCE WITH YOUR ENJOYMENT OF THE SOFTWARE OR AGAINST INFRINGEMENT.** IF YOU HAVE RECEIVED ANY WARRANTIES REGARDING THE DEVICE OR THE SOFTWARE, THOSE WARRANTIES DO NOT ORIGINATE FROM, AND ARE NOT BINDING ON, MS.

**Note on Java support.** The SOFTWARE may contain support for programs written in Java. Java technology is not fault tolerant and is not designed, manufactured, or intended for use or resale as online control equipment in hazardous environments requiring fail-safe performances, such as in the operation of nuclear facilities, aircraft navigation or communication systems, air traffic control, direct life support machines, or weapons systems, in which the failure of Java technology could lead directly to death, personal injury, or severe physical or environmental damage. Sun Microsystems, Inc. has contractually obligated MS to make this disclaimer.

**No Liability for Certain Damages.** EXCEPT AS PROHIBITED BY LAW, MS SHALL HAVE NO LIABILITY FOR ANY INDIRECT, SPECIAL, CONSEQUENTIAL OR INCIDENTAL DAMAGES ARISING FROM OR IN CONNECTION WITH THE USE OR PERFORMANCE OF THE SOFTWARE. THIS LIMITATION SHALL APPLY EVEN IF ANY REMEDY FAILS OF ITS ESSENTIAL PURPOSE. IN



NO EVENT SHALL MS BE LIABLE FOR ANY AMOUNT IN EXCESS OF U.S. TWO HUNDRED FIFTY DOLLARS (U.S.\$250.00).

**Limitations on Reverse Engineering, Decompilation, and Disassembly.** You may not reverse engineer, decompile, or disassemble the SOFTWARE, except and only to the extent that such activity is expressly permitted by applicable law notwithstanding this limitation.

**SOFTWARE TRANSFER ALLOWED BUT WITH RESTRICTIONS.** You may permanently transfer rights under this End User License Agreement only as part of a permanent sale or transfer of the Device, and only if the recipient agrees to this End User License Agreement. If the SOFTWARE is an upgrade, any transfer must also include all prior versions of the SOFTWARE.

**EXPORT RESTRICTIONS.** You acknowledge that SOFTWARE is of US-origin. You agree to comply with all applicable international and national laws that apply to the SOFTWARE, including the U.S. Export Administration Regulations, as well as end-user, end-use, and country destination restrictions issued by U.S. and other governments. For additional information on exporting the SOFTWARE, see <http://www.microsoft.com/exporting>.